

RoHS

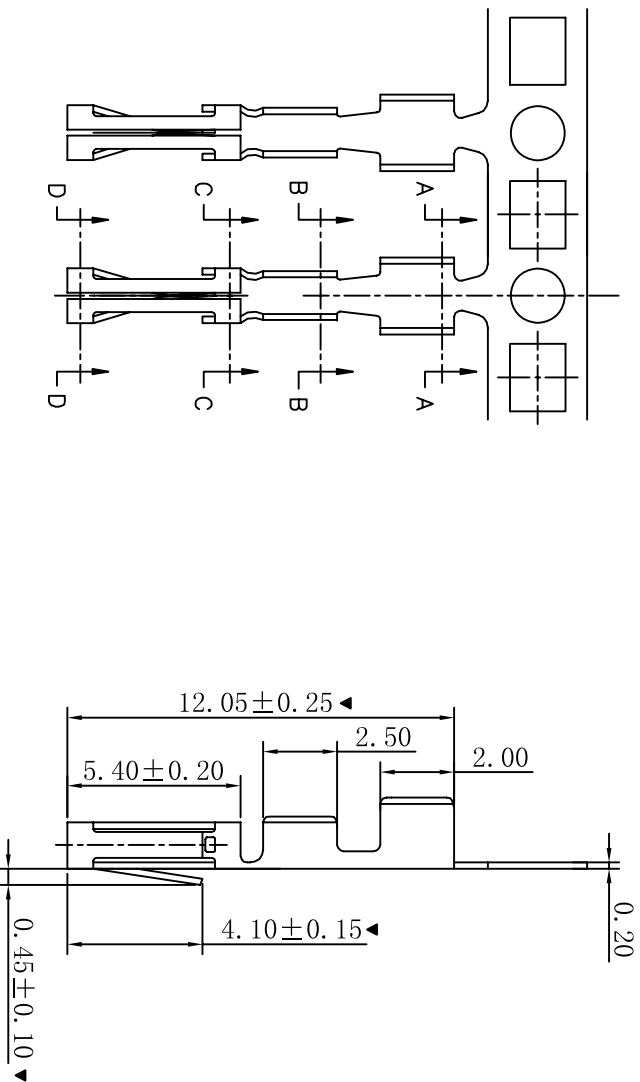

■ SPECIFICATIONS

- Voltage rating: 250V AC, DC
- Current rating: 3A, AC, DC
- Withstanding Voltage: 1000V AC/minute
- Insulation resistance: 1000MΩ min
- Temperature range: -25° C~+85° C
- Contact resistance: 20mΩ max

■ TERMINAL

- Part No. : T2543PT
- Applicable wire: AWG#22-#26
- Material: Phosphor Bronze
- Finish: Tin Plated
- The Dimension Marked "▼" Must Be Recorded

SEC: A-A

SEC: B-B

SEC: C-C

SEC: D-D

C	修订版本	2015-11-04	陈雄军						
B	变更图章格式内容	2013-12-27	陈雄军						
A	新版本	2011-05-24	陈雄军						
H	说明	日期	承认						
	版次								
	REV.								

一般公差	0±0.30
GENERAL TOLERANCE:	.00±0.25
	.000±0.05
	ANGLE: ±1°
绘图/DR	陈雄军
审核/CHECK	胡进
核准/APPRO	MR. feng
日期/DATE	2015-11-04

XYDZ® 东莞市祥运连接器有限公司	
Connectors	
Dongguan XiangYun Connectors CO., Ltd	
投影法	第一角
单位 Unit	MM
比例/Scale	1:1
大小/SIZE	A4
页码/SHEET	1/1
版本/Rev	C
品名	AMP2.54mm Female Terminal
(PART NAME)	Connector Series
料号	T2543PT
(PART NO)	

RoHS

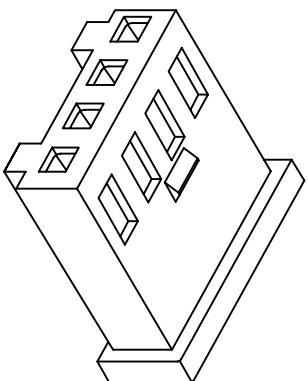
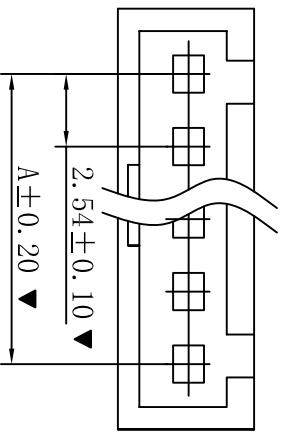

- SPECIFICATIONS**
- Voltage rating: 250V AC, DC
 - Current rating: 3A, AC, DC
 - Withstanding Voltage: 1000V AC/minute
 - Insulation resistance: 1000MΩ min
 - Temperature range: -25° C~+85° C
 - Contact resistance: 20mΩ max
- HOUSING**
- Part No. : H2543-NP
 - Poles : 02-22P
 - Housing Material: PBT UL94V-0 Black
- The Dimension Marked “▼” Must Be Recorded

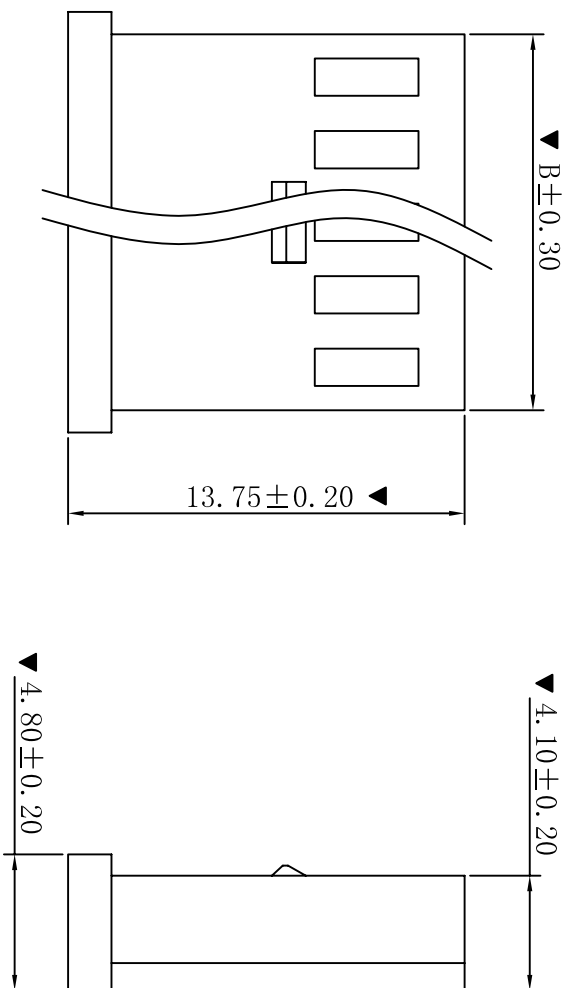

PART NO.	Dimensions (mm)	
	A	B
02	2.54	5.60
03	5.08	8.14
04	7.62	10.68
05	10.16	13.22
06	12.70	15.76
07	15.24	18.30
08	17.78	20.84
09	20.32	23.38
10	22.86	25.92
11	25.40	28.46
12	27.94	31.00
13	30.48	33.54
14	33.02	36.08
15	35.56	38.62
16	38.10	41.16
17	40.64	43.70
18	43.18	46.24
19	45.72	48.78
20	48.26	51.32
21	50.80	53.86
22	53.34	56.40

一般公差 GENERAL TOLERANCE:		0±0.30 .0±0.25 .000±0.05
角度/DR ANGLE:		±1°
修订版本	2015-11-04	陈雄军
变更图章格式内容	2013-12-27	陈雄军
新版本	2011-05-24	陈雄军
说明 DESCRIPTION	日期 DATE:	承认 APPRO.

XYDZ® 东莞市祥运连接器有限公司
Dongguan Xiangyun Connectors CO., Ltd

投影法 Projection	MM
单位/Unit	MM
比例/Scale	1:1
大小/SIZE	A4
页码/SHEET	1/1
版本/rev	C

品名 (PART NAME): AMP2.54mm Housing Connector Series

料号 (PART NO): H2543-NP

RoHS

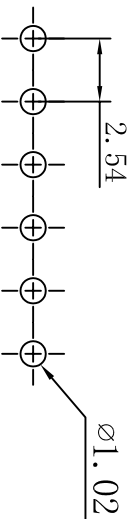
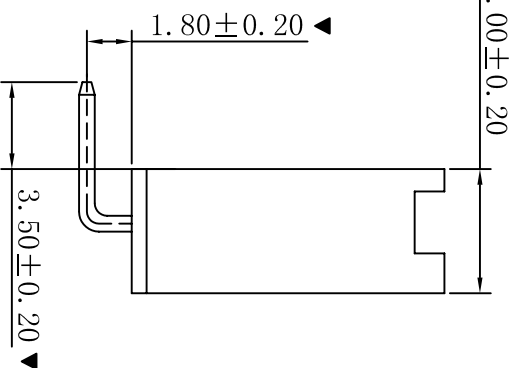
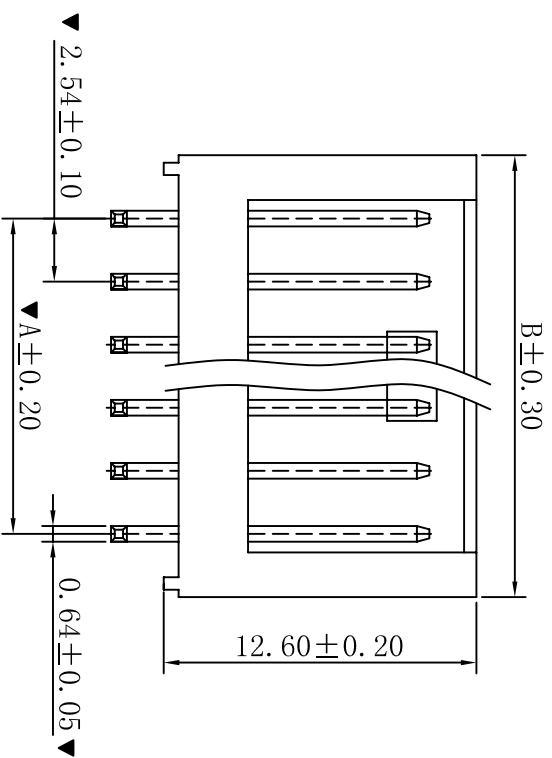
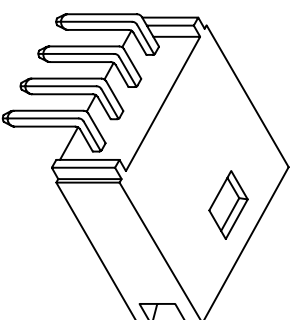
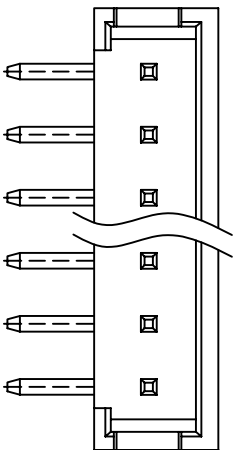

P. C. B LAYOUT

■ SPECIFICATIONS

- Voltage rating: 250V AC, DC
- Current rating: 3A, AC, DC
- Withstanding Voltage: 1000V AC/minute
- Insulation resistance: 1000MΩ min
- Temperature range: -25° C ~ +85° C
- Contact resistance: 20mΩ max

■ WAFER

- Part No. : W2543R-NP
- Poles : 02-22P
- Housing Material : Nylon66 UL94V-2 Black
- Pin Material : Brass
- Contact Area Plating : Tin-Plated
- The Dimension Marked "▼" Must Be Recorded

PART NO.	Dimensions (mm)	
	A	B
02	2.54	7.70
03	5.08	10.20
04	7.62	12.70
05	10.16	15.20
06	12.70	17.80
07	15.24	20.30
08	17.78	22.90
09	20.32	25.40
10	22.86	28.00
11	25.40	30.50
12	27.94	33.10
13	30.48	35.60
14	33.02	38.10
15	35.56	40.70
16	38.10	43.20
17	40.64	45.70
18	43.18	48.20
19	45.72	50.70
20	48.26	53.20
21	50.80	55.70
22	53.34	58.50

XYDZ® 东莞市祥运连接器有限公司
 Dongguan XiangYun Connectors CO., Ltd

一般公差 GENERAL TOLERANCE:	0±0.30 .0±0.25 .000±0.20
ANGLE: ±1°	

投影法
Projection



单位 Unit: MM

比例/Scale: 1:1

大小/SIZE: A4

页码/SHEET: 1/1

版本/Rev: C

品名 (PART NAME): AMP2.54mm 90° Wafer
 Connector Series

料号 (PART NO): W2543R-NP

修订版本	2015-11-04	陈雄军
变更图宽格式内容	2013-12-27	陈雄军
新版本	2011-05-24	陈雄军
说明	日期	承认
DESCRIPTION	DATE	APPRO.

绘图/DR	陈雄军
审核/CHECK	胡进
批准/APPRO	MR. Feng
日期/DATE	2015-11-04

日期/DATE	2015-11-04
---------	------------

日期/DATE	2015-11-04
---------	------------

版次 REV. 1

说明 DESCRIPTION

日期 DATE

承认 APPRO.

审核/CHECK

批准/APPRO

绘图/DR

单位 Unit: MM

比例/Scale: 1:1

大小/SIZE: A4

页码/SHEET: 1/1

版本/Rev: C

品名 (PART NAME): AMP2.54mm 90° Wafer
Connector Series

料号 (PART NO): W2543R-NP

RoHS

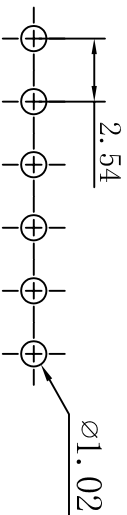
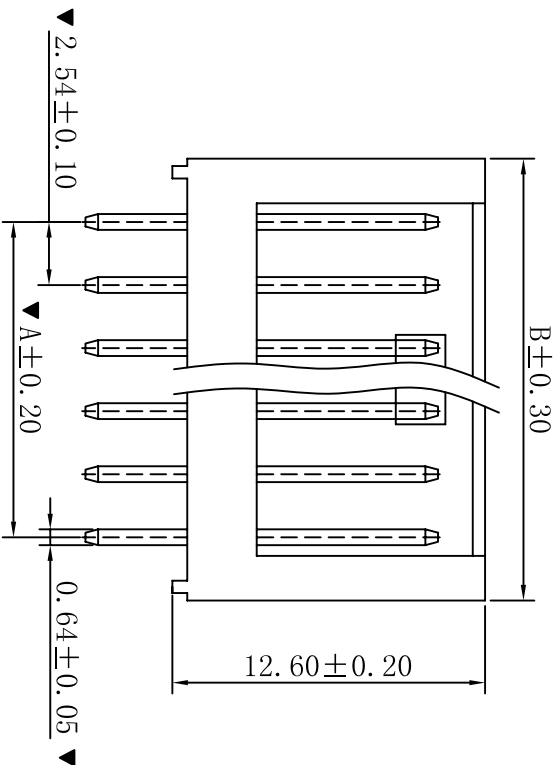
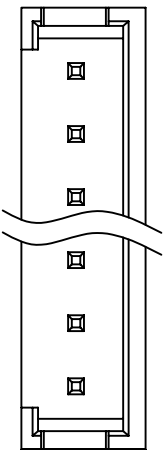

P. C. B LAYOUT

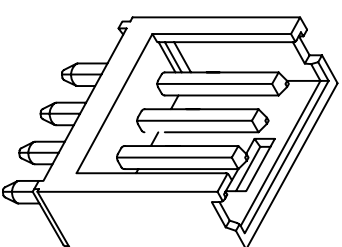
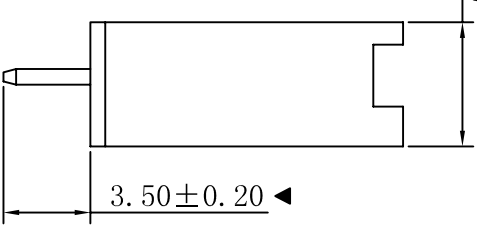

■ SPECIFICATIONS

- Voltage rating: 250V AC, DC
- Current rating: 3A, AC, DC
- Withstanding Voltage: 1000V AC/minute
- Insulation resistance: 1000MΩ min
- Temperature range: -25° C ~ +85° C
- Contact resistance: 20mΩ max

■ WAFER

- Part No. : W2543V-NP
- Poles : 02-22P
- Housing Material : Nylon66 UL94V-2 Black
- Pin Material : Brass
- Contact Area Plating : Tin-Plated
- The Dimension Marked "▼" Must Be Recorded

PART NO.	Dimensions (mm)	
	A	B
02	2.54	7.70
03	5.08	10.20
04	7.62	12.70
05	10.16	15.20
06	12.70	17.80
07	15.24	20.30
08	17.78	22.90
09	20.32	25.40
10	22.86	28.00
11	25.40	30.50
12	27.94	33.10
13	30.48	35.60
14	33.02	38.10
15	35.56	40.70
16	38.10	43.20
17	40.64	45.70
18	43.18	48.20
19	45.72	50.70
20	48.26	53.20
21	50.80	55.70
22	53.34	58.50

XYDZ® 东莞市祥运连接器有限公司
 Dongguan XiangYun Connectors CO., Ltd

一般公差 GENERAL TOLERANCE:	0±0.30 .0±0.25 .00±0.20 .000±0.05
投影法 Projection	第一角投影 ANGLE: ±1°

Connectors

AMP2.54mm 180° Wafer Connector Series

修订版本	2015-11-04	陈雄军
变更图宽格式内容	2013-12-27	陈雄军
新版本	2011-05-24	陈雄军
说明	日期	承认
DESCRIPTION	DATE	APPRO.

审核/DR	陈雄军
审核/CHECK	胡进
核准/APPRO	MR. feng
日期/DATE	2015-11-04

品名 (PART NAME)	料号 (PART NO)
MM	W2543V-NP
比例/Scale 1:1	
大小/SIZE A4	
页码/SHEET 1/1	
版本/rev C	

RoHS

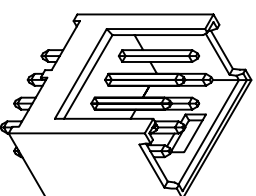
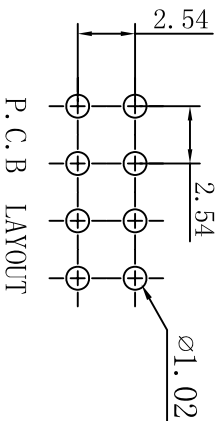
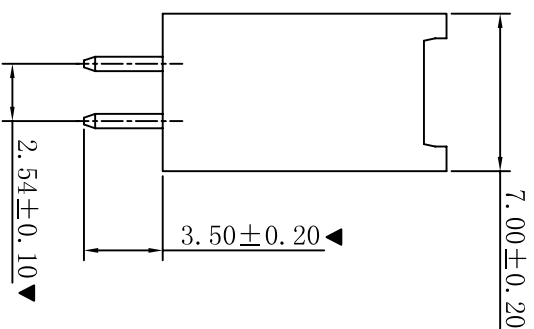
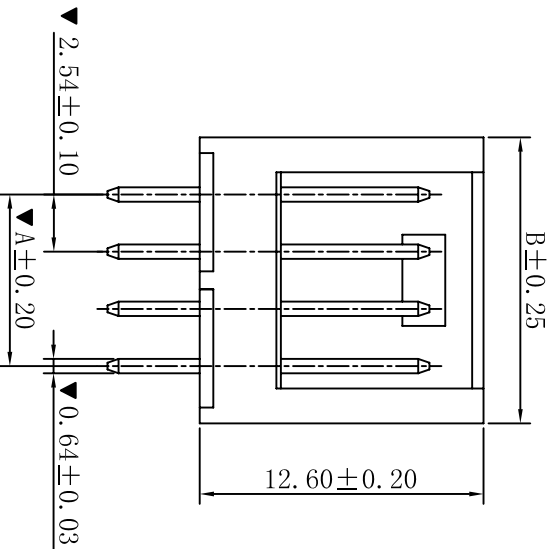
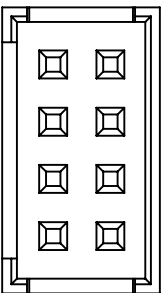

■ SPECIFICATIONS

- Voltage rating: 250V AC, DC
- Current rating: 3A, AC, DC
- Withstanding Voltage: 1000V AC/minute
- Insulation resistance: 1000MΩ min
- Temperature range: -25° C~+85° C
- Contact resistance: 20mΩ max

■ WAFER

- Part No. : W2543V-2xNP
- Poles : 04-64P
- Housing Material : PBT UL94V-0 Black
- Pin Material : Brass
- Contact Area Plating : Tin-Plated
- The Dimension Marked “▼” Must Be Recorded

PART NO.	Dimensions		PART NO.	Dimensions	
	A	B		A	B
2x2P	2.54	7.46	2x17P	40.64	45.56
2x3P	5.08	10.00	2x18P	43.18	48.10
2x4P	7.62	12.54	2x19P	45.72	50.64
2x5P	10.16	15.08	2x20P	48.26	53.18
2x6P	12.70	17.62	2x21P	50.80	55.72
2x7P	15.24	20.16	2x22P	53.34	58.26
2x8P	17.78	22.70	2x23P	55.88	60.80
2x9P	20.32	25.24	2x24P	58.42	63.34
2x10P	22.86	27.78	2x25P	60.96	65.88
2x11P	25.40	30.32	2x26P	63.50	68.42
2x12P	27.94	32.86	2x27P	66.04	70.96
2x13P	30.48	35.40	2x28P	68.58	73.50
2x14P	33.02	37.94	2x29P	71.12	76.04
2x15P	35.56	40.48	2x30P	73.66	78.58
2x16P	38.10	43.02	2x31P	76.20	81.12
			2x32P	78.74	83.66

XYZD[®] 东莞市祥运连接器有限公司
Dongguan XiangYun Connectors CO., Ltd

一般公差 GENERAL TOLERANCE:	0±0.30 .0±0.25 .000±0.05
角度/DR	ANGLE: ±1°

投影法
Projection

单位 Unit	MM
比例/Scale	1:1
大小/SIZE	A4
页码/SHEET	1/1
版本/REV	C

品名
(PART NAME)

AMP2.54mm 180° Wafer
Connector Series

料号
(PART NO)

W2543V-2xNP

修订版本	2015-11-04	陈雄军
变更图宽格式内容	2013-12-27	陈雄军
新版本	2011-05-24	陈雄军
说明 DESCRIPTION	日期 DATE	承认 APPRO.

版次 REV.	1	2	3	4	5	6	7	8	9	10
------------	---	---	---	---	---	---	---	---	---	----