

ROHS

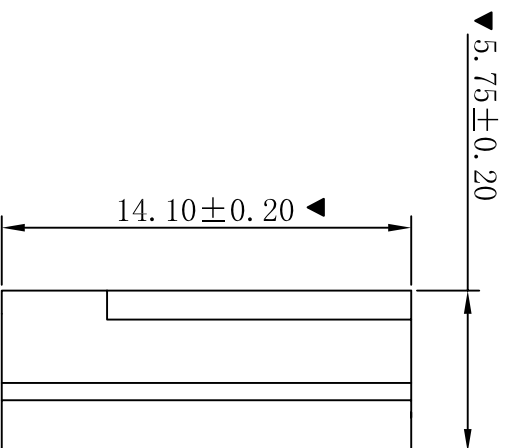
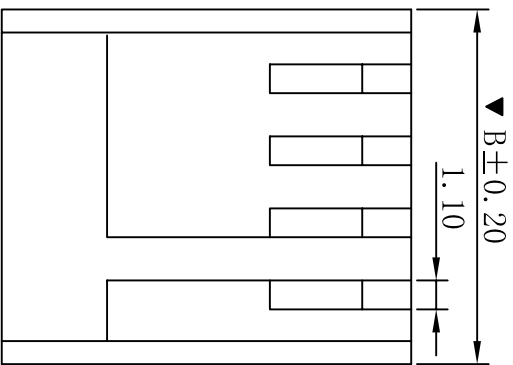
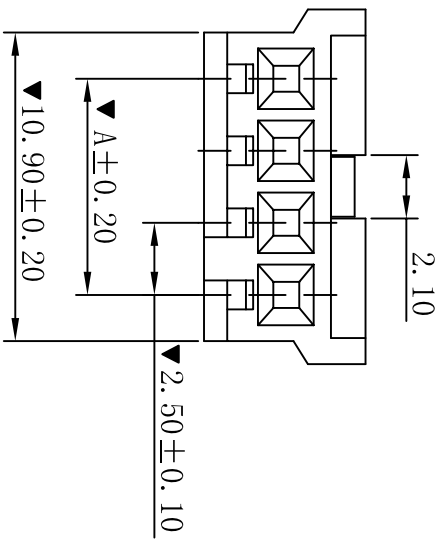

■ SPECIFICATIONS

- Voltage rating: 250V AC, DC
- Current rating: 3A, AC, DC
- Withstanding Voltage: 1500V AC/minute
- Insulation resistance: 1000MΩ min
- Temperature range: -25° C~+85° C
- Contact resistance: 20mΩ max

■ HOUSING

- Part No. : H2540-NP (D)
- Poles : 02-12P
- Housing Material : Nylon66 UL94V-0
- The Dimension Marked “▼” Must Be Recorded

PART NO.	Dimensions (mm)	
	A	B
02	2.50	7.50
03	5.00	10.00
04	7.50	12.50
05	10.00	15.00
06	12.50	17.50
07	15.00	20.00
08	17.50	22.50
09	20.00	25.00
10	22.50	27.50
11	25.00	30.00
12	27.50	32.50

修订版本		2015-11-04	陈雄军	一般公差 GENERAL TOLERANCE:		0±0.30 .0±0.25 .00±0.20 .000±0.05
变更图章格式内容		2013-12-27	陈雄军	绘图/DR		陈雄军
新版本		2011-05-24	陈雄军	审核/CHECK		胡进
说明		日期	承认	批准/APPRO		MR. feng
DESCRIPTION		DATE	APPRO.	日期/DATE		2015-11-04

<p>XYDZ® 东莞市祥运连接器有限公司 Dongguan Xiangyun Connectors Co., Ltd</p>		投影法 Projection	品名 (PART NAME)	AMP2.50mm Male Housing Connector Series
		单位 Unit	料号 (PART NO)	H2540-NP (D)
		比例/Scale		
		大小/SIZE		
		页码/SHEET		
		版本/Rev		

RoHS

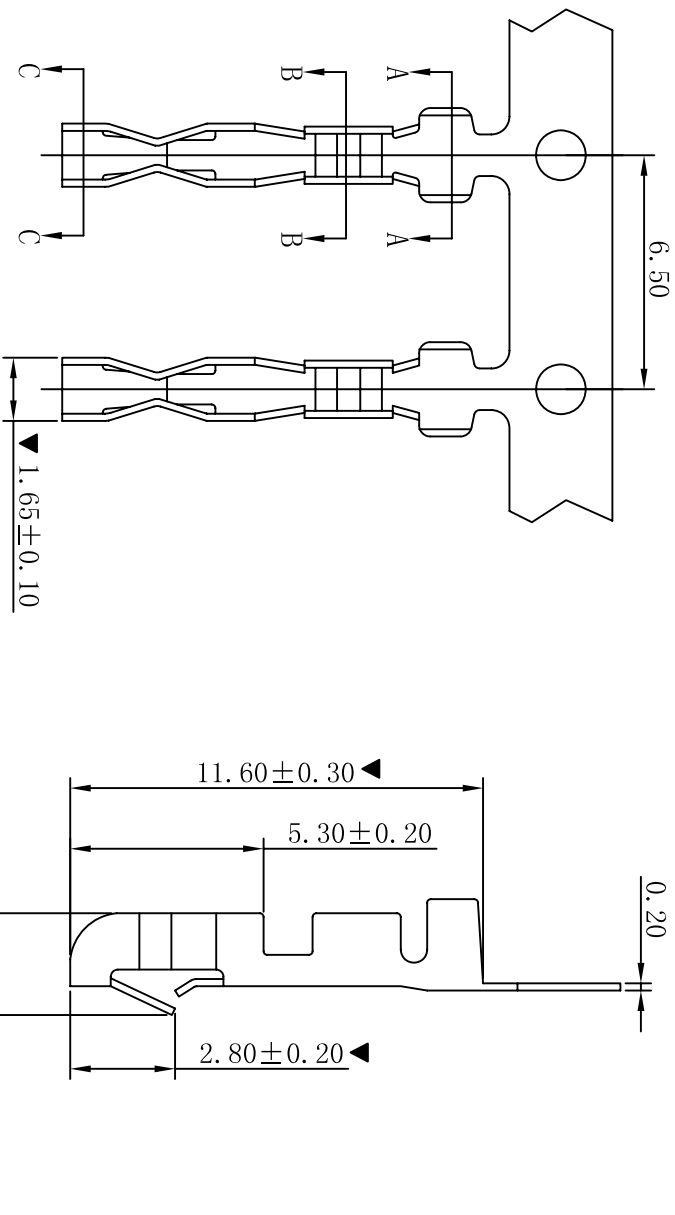

■ SPECIFICATIONS

- Voltage rating: 250V AC, DC
- Current rating: 3A, AC, DC
- Withstanding Voltage: 1500V AC/minute
- Insulation resistance: 1000MΩ min
- Temperature range: -25° C ~ +85° C
- Contact resistance: 20mΩ max

■ TERMINAL

- Part No. : T2540BT (D)
- Applicable wire: AWG#20-#24
- Material: Brass
- Finish: Tin Plated
- The Dimension Marked "▼" Must Be Recorded

修订版本		2015-11-04		陈雄军		一般公差 GENERAL TOLERANCE:		0 ± 0.30 .0 ± 0.25 .000 ± 0.20 ANGLE: ± 1°		投影法 Projection		品名 (PART NAME)		AMP2.50mm Female Terminal Connector Series	
变更图章格式内容		2013-12-27		陈雄军		绘图/DR		陈雄军		单位 Unit		MM			
新版本		2011-05-24		陈雄军		审核/CHECK		胡进		比例/Scale		1:1			
说明 DESCRIPTION		日期 DATE		承认 APPRO.		核准/APPRO		MR. feng		大小/SIZE		A4		料号 (PART NO)	
1		2		3		4		5		6		7		8	
1		2		3		4		5		6		7		8	

XYDZ® 东莞市祥运连接器有限公司
Dongguan XiangYun Connectors CO., Ltd

T2540BT (D)

RoHS

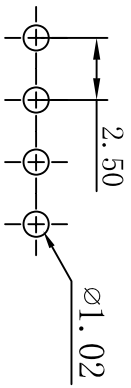
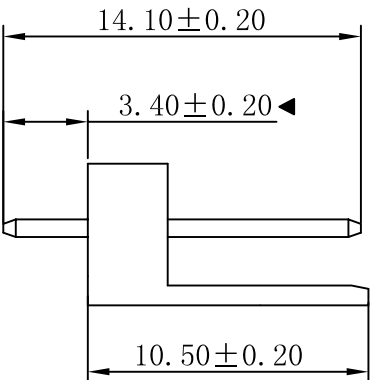
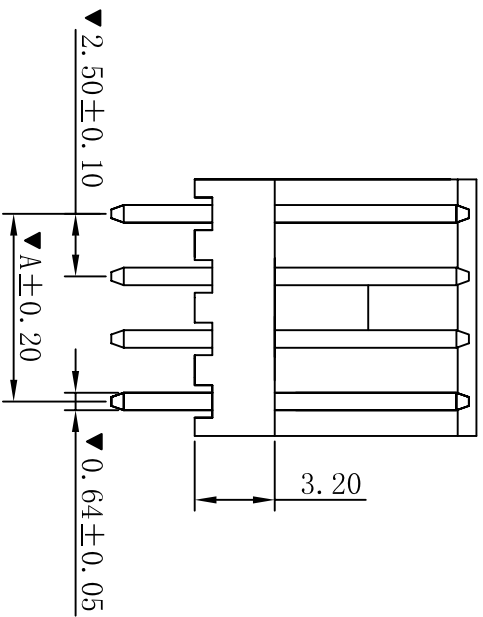
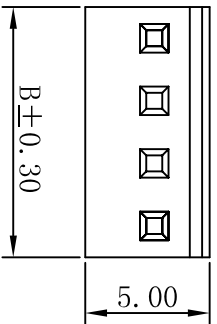

P. C. B LAYOUT

■ SPECIFICATIONS

- Voltage rating: 250V AC, DC
- Current rating: 3A, AC, DC
- Withstanding Voltage: 1500V AC/minute
- Insulation resistance: 1000MΩ min
- Temperature range: -25° C ~ +85° C
- Contact resistance: 20mΩ max

■ WAFER

- Part No. : W2540V-NP
- Poles : 02-12P
- Housing Material: Nylon66 UL94V-0
- Pin Material: Brass
- Contact Area Plating: Tin-Plated
- The Dimension Marked "▼" Must Be Recorded

Part No.	Dimension (mm)	
	A	B
02	2.50	5.00
03	5.00	7.50
04	7.50	10.00
05	10.00	12.50
06	12.50	15.00
07	15.00	17.50
08	17.50	20.00
09	20.00	22.50
10	22.50	25.00
11	25.00	27.50
12	27.50	30.00

XYDZ® 东莞市祥运连接器有限公司
 Dongguan XiangYun Connectors Co., Ltd

一般公差 GENERAL TOLERANCE:	0±0.30 .0±0.25 .00±0.20 .000±0.05
ANGLE: ±1°	

绘图/DR	陈雄军
审核/CHECK	胡进
批准/APPRO	MR. feng
日期/DATE	2015-11-04

投影法 Projection	第一角投影
单位 Unit	MM
比例/Scale	1:1
大小/SIZE	A4
页码/SHEET	1/1
版本/rev	C

品名 (PART NAME)	AMP2.50mm 180° Wafer Connector Series
料号 (PART NO)	W2540V-NP

修订版本	2015-11-04	陈雄军
变更图章格式内容	2013-12-27	陈雄军
新版本	2011-05-24	陈雄军
说明 DESCRIPTION	日期 DATE	承认 APPRO.

1 2 3 4 5 6 7 8 9 10

ROHS

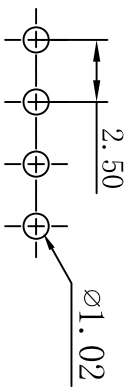
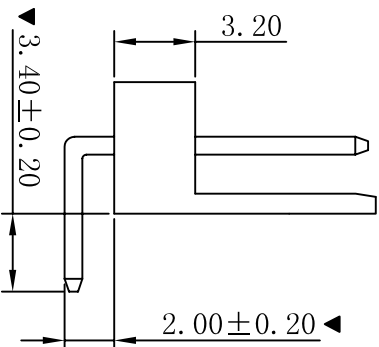
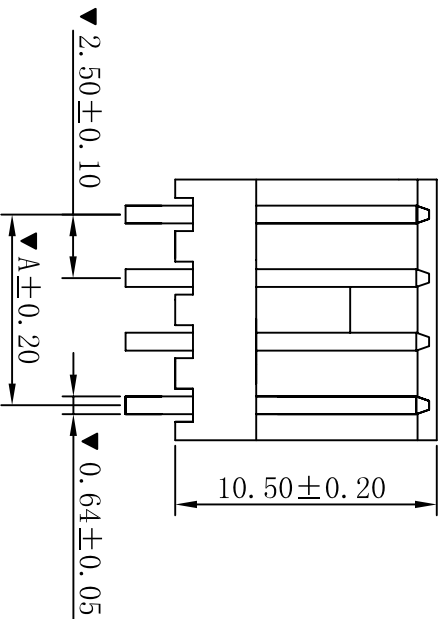
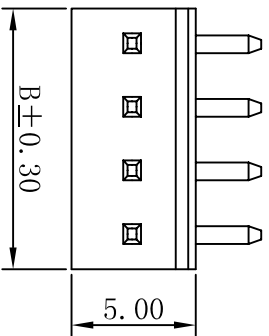

P.C.B LAYOUT

■ SPECIFICATIONS

- Voltage rating: 250V AC, DC
- Current rating: 3A, AC, DC
- Withstanding Voltage: 1500V AC/minute
- Insulation resistance: 1000MΩ min
- Temperature range: -25° C~+85° C
- Contact resistance: 20mΩ max

■ WAFER

- Part No. : W2540R-NP
- Poles : 02-12P
- Housing Material: Nylon66 UL94V-0
- Pin Material: Brass
- Contact Area Plating: Tin-Plated
- The Dimension Marked "▼" Must Be Recorded

Part No.	Dimension (mm)	
	A	B
02	2.50	5.00
03	5.00	7.50
04	7.50	10.00
05	10.00	12.50
06	12.50	15.00
07	15.00	17.50
08	17.50	20.00
09	20.00	22.50
10	22.50	25.00
11	25.00	27.50
12	27.50	30.00

XYDZ® 东莞市祥运连接器有限公司
 Dongguan XiangYun Connectors CO., Ltd

一般公差 GENERAL TOLERANCE:	0±0.30 .0±0.25 .000±0.20
绘图/DR	陈雄军
审核/CHECK	胡进
批准/APPRO	MR. feng
日期/DATE	2015-11-04

投影法 Projection	MM
单位 Unit	MM
比例/Scale	1:1
大小/SIZE	A4
页码/SHEET	1/1
版本/rev	C

品名 (PART NAME)	AMP2.50mm 90° Wafer Connector Series
料号 (PART NO)	W2540R-NP

修订版本	2015-11-04	陈雄军
变更图章格式内容	2013-12-27	陈雄军
新版本	2011-05-24	陈雄军
说明 DESCRIPTION	日期 DATE	承认 APPRO.

1 2 3 4 5 6 7 8 9 10