

RoHS

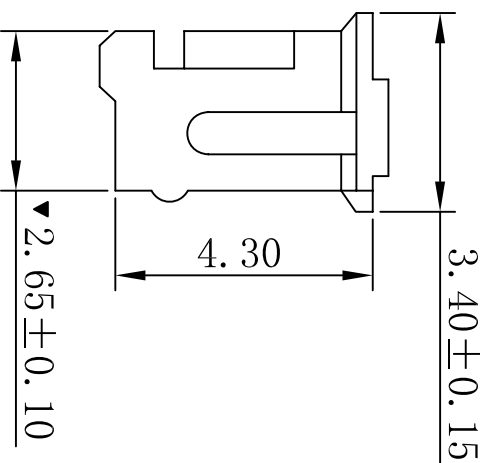
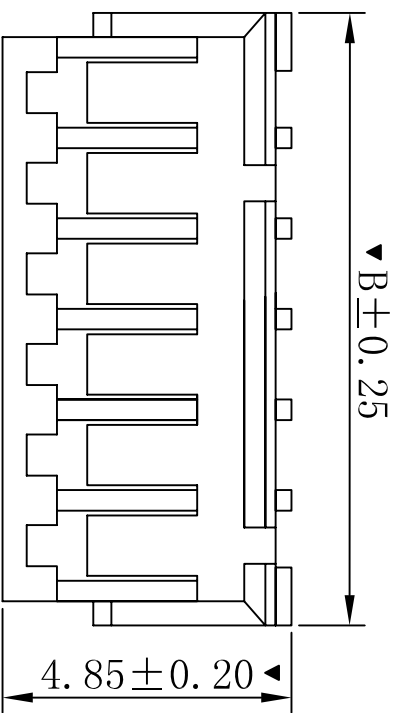
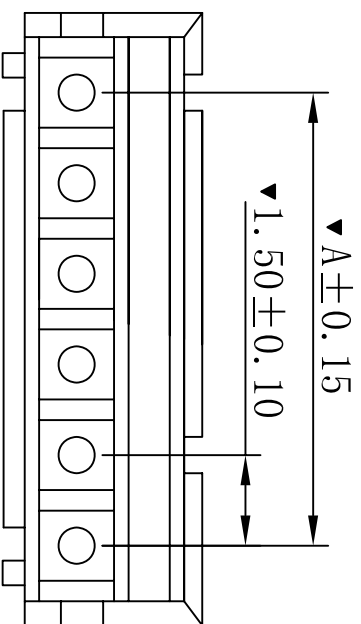

■ SPECIFICATIONS

- Voltage Rating: 50V AC, DC
- Current Rating: 1.0A, AC, DC
- Withstanding Voltage: 500V AC/minute
- Insulation Resistance: 100MΩ min
- Temperature range: -25° C~+85° C
- Contact resistance: 40mΩ max

■ HOUSING

- Part No. : H1500-NP
- Poles: 02-13P
- Housing Material: Nylon66 UL94V-0
- The Dimension Marked “▼” Must Be Recorded

PART NO.	Dimensions (mm)	
	A	B
02	1.50	4.50
03	3.00	6.00
04	4.50	7.50
05	6.00	9.00
06	7.50	10.50
07	9.00	12.00
08	10.50	13.50
09	12.00	15.00
10	13.50	16.50
11	15.00	18.00
12	16.50	19.50
13	18.00	21.00

	修订版本	2015-11-04	陈雄军
	变更图章格式内容	2013-12-27	陈雄军
	新版本	2011-05-24	陈雄军
	说明	日期	承认
	DESCRIPTION	DATE	APPRO.

一般公差	0±0.30
GENERAL TOLERANCE:	.00±0.25
	.000±0.05
ANGLE:	±1°
绘图/DR	陈雄军
审核/CHECK	胡进
核准/APPRO	MR. feng
日期/DATE	2016-03-04

<p>XYDZ® 东莞市祥运连接器有限公司</p> <p>Connectors Dongguan XiangYun Connectors CO., Ltd</p>	
投影法	第一角法
单位 Unit	MM
比例/Scale	1:1
大小/SIZE	A4
页码/SHEET	1/1
版本/Rev	C
品名	ZH1.50mm Male Housing
(PART NAME)	Connector Series
料号	H1500-NP
(PART NO)	

RoHS

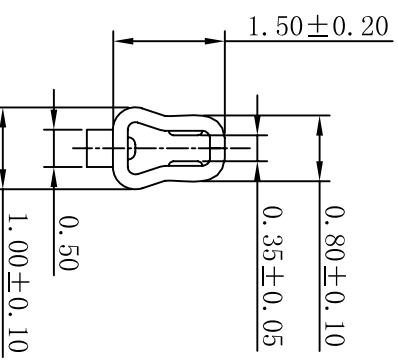
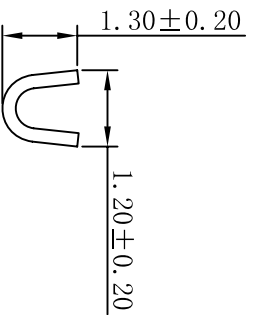
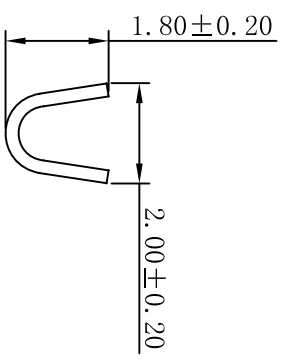
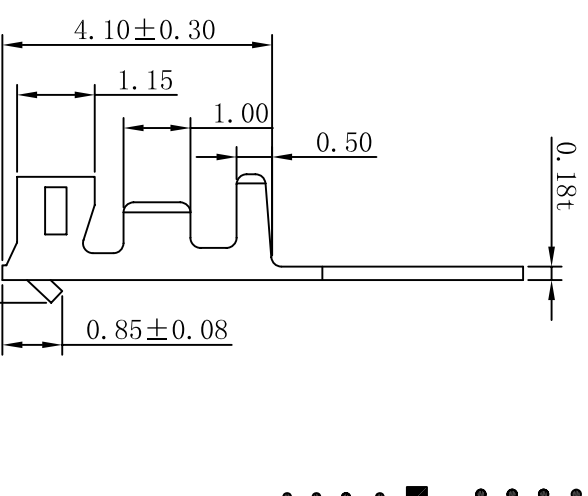
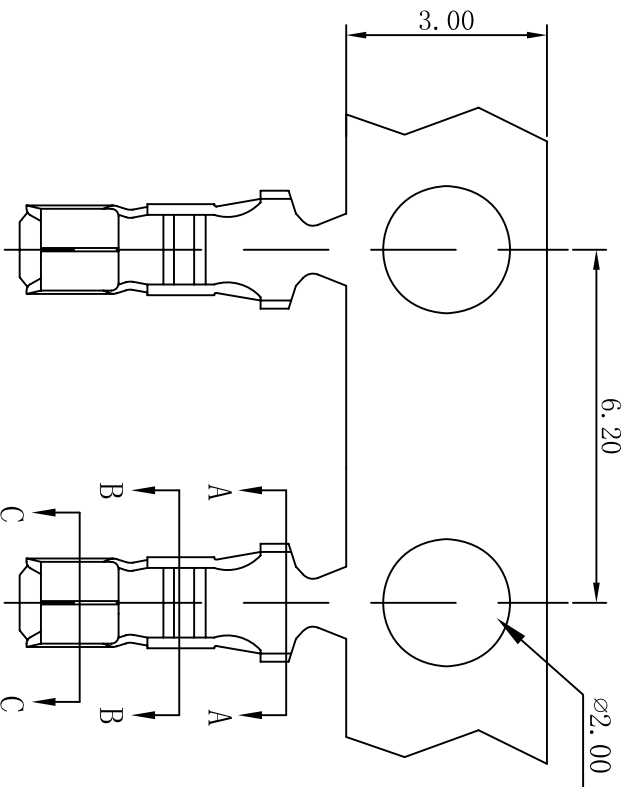

■ SPECIFICATIONS

- Voltage Rating: 50V AC, DC
- Current Rating: 1.0A, AC, DC
- Withstanding Voltage: 500V AC/minute
- Insulation Resistance: 100M Ω min
- Temperature range: -25 $^{\circ}$ C~+85 $^{\circ}$ C
- Contact resistance: 40m Ω max

■ TERMINAL

- Part No. : T1500PT
- Applicable wire: AWG#26-#32
- Material: Phosphor Bronze
- Finish: Tin plated

<p>XYDZ[®] 东莞市祥运连接器有限公司 Dongguan Xiangyun Connectors CO., Ltd</p>		<p>投影法 Connectors</p>		<p>一般公差 GENERAL TOLERANCE: ANGLE: $\pm 1^{\circ}$</p>		<p>0\pm0.30 .0\pm0.25 .000\pm0.05</p>		<p>单位 Unit: MM 比例/Scale: 1:1 大小/SIZE: A4 页码/SHEET: 1/1 版本/rev: C</p>		<p>品名 (PART NAME): ZH1.50mm Female Terminal Connector Series 料号 (PART NO): T1500PT</p>	
<p>修订版本 变更图章格式内容</p>		<p>绘图/DR: 陈雄军</p>		<p>公差 GENERAL TOLERANCE: ANGLE: $\pm 1^{\circ}$</p>		<p>0\pm0.30 .0\pm0.25 .000\pm0.05</p>		<p>投影法 Connectors</p>		<p>品名 (PART NAME): ZH1.50mm Female Terminal Connector Series 料号 (PART NO): T1500PT</p>	
<p>新版本 说明</p>		<p>审核/CHECK: 胡进</p>		<p>公差 GENERAL TOLERANCE: ANGLE: $\pm 1^{\circ}$</p>		<p>0\pm0.30 .0\pm0.25 .000\pm0.05</p>		<p>单位 Unit: MM 比例/Scale: 1:1 大小/SIZE: A4 页码/SHEET: 1/1 版本/rev: C</p>		<p>品名 (PART NAME): ZH1.50mm Female Terminal Connector Series 料号 (PART NO): T1500PT</p>	
<p>版次 REV. 1</p>		<p>日期 DATE: 2011-05-24</p>		<p>公差 GENERAL TOLERANCE: ANGLE: $\pm 1^{\circ}$</p>		<p>0\pm0.30 .0\pm0.25 .000\pm0.05</p>		<p>单位 Unit: MM 比例/Scale: 1:1 大小/SIZE: A4 页码/SHEET: 1/1 版本/rev: C</p>		<p>品名 (PART NAME): ZH1.50mm Female Terminal Connector Series 料号 (PART NO): T1500PT</p>	
<p>说明 DESCRIPTION</p>		<p>日期 DATE: 2017-01-10</p>		<p>公差 GENERAL TOLERANCE: ANGLE: $\pm 1^{\circ}$</p>		<p>0\pm0.30 .0\pm0.25 .000\pm0.05</p>		<p>单位 Unit: MM 比例/Scale: 1:1 大小/SIZE: A4 页码/SHEET: 1/1 版本/rev: C</p>		<p>品名 (PART NAME): ZH1.50mm Female Terminal Connector Series 料号 (PART NO): T1500PT</p>	
<p>日期 DATE: 2015-11-04</p>		<p>日期 DATE: 2013-12-27</p>		<p>公差 GENERAL TOLERANCE: ANGLE: $\pm 1^{\circ}$</p>		<p>0\pm0.30 .0\pm0.25 .000\pm0.05</p>		<p>单位 Unit: MM 比例/Scale: 1:1 大小/SIZE: A4 页码/SHEET: 1/1 版本/rev: C</p>		<p>品名 (PART NAME): ZH1.50mm Female Terminal Connector Series 料号 (PART NO): T1500PT</p>	
<p>日期 DATE: 2011-05-24</p>		<p>日期 DATE: 2017-01-10</p>		<p>公差 GENERAL TOLERANCE: ANGLE: $\pm 1^{\circ}$</p>		<p>0\pm0.30 .0\pm0.25 .000\pm0.05</p>		<p>单位 Unit: MM 比例/Scale: 1:1 大小/SIZE: A4 页码/SHEET: 1/1 版本/rev: C</p>		<p>品名 (PART NAME): ZH1.50mm Female Terminal Connector Series 料号 (PART NO): T1500PT</p>	
<p>日期 DATE: 2017-01-10</p>		<p>日期 DATE: 2017-01-10</p>		<p>公差 GENERAL TOLERANCE: ANGLE: $\pm 1^{\circ}$</p>		<p>0\pm0.30 .0\pm0.25 .000\pm0.05</p>		<p>单位 Unit: MM 比例/Scale: 1:1 大小/SIZE: A4 页码/SHEET: 1/1 版本/rev: C</p>		<p>品名 (PART NAME): ZH1.50mm Female Terminal Connector Series 料号 (PART NO): T1500PT</p>	

RoHS

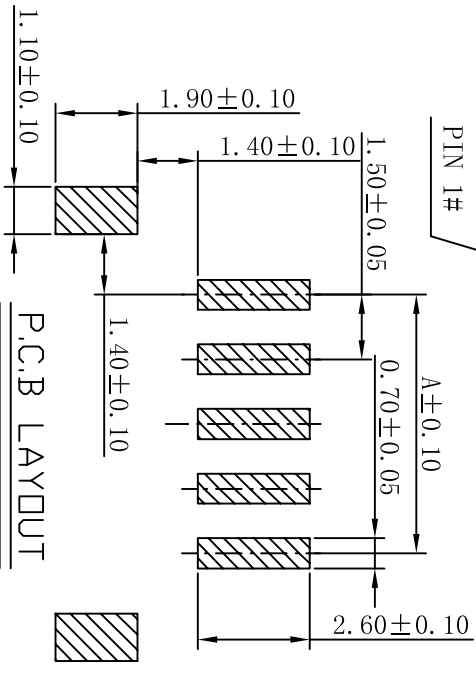
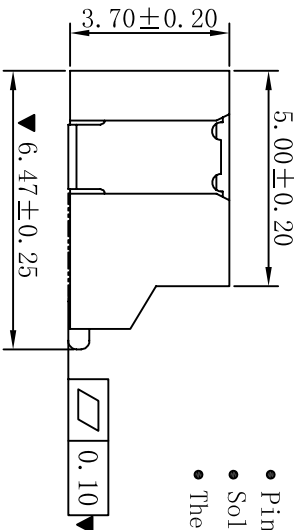
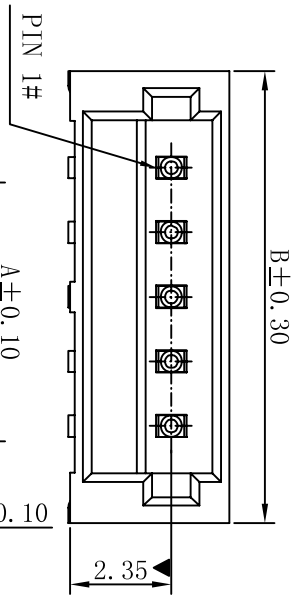
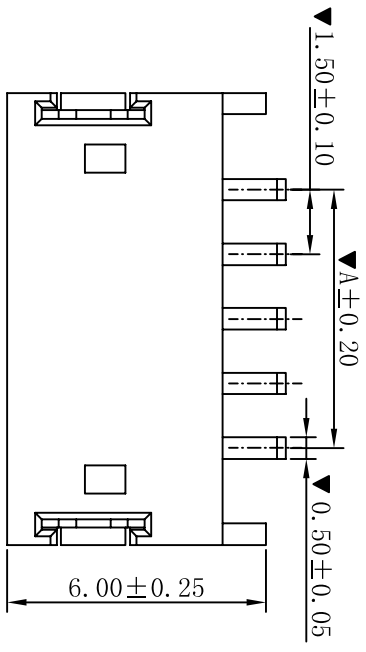

- SPECIFICATIONS
- Voltage Rating: 50V AC, DC
 - Current Rating: 1.0A, AC, DC
 - Withstanding Voltage: 500V AC/minute
 - Insulation Resistance: 100MΩ min
 - Temperature range: -25° C~+85° C
 - Contact resistance: 40mΩ max

- WAFER
- Part No. : W1500SR-NP
 - Poles : 02-15P
 - Housing Material: Nylon 6T UL94V-0
 - Pin Material: Brass /Tin-plated
 - Solder Tab Material: Brass /Tin-plated
 - The Dimension Marked "▼" Must Be Recorded

Contacts	Dimension (mm)	
	A	B
02	1.50	6.00
03	3.00	7.50
04	4.50	9.00
05	6.00	10.50
06	7.50	12.00
07	9.00	13.50
08	10.50	15.00
09	12.00	16.50
10	13.50	18.00
11	15.00	19.50
12	16.50	21.00
13	18.00	22.50
14	19.50	24.00
15	21.00	25.50

一般公差 GENERAL TOLERANCE:	0±0.20 .0±0.13 .00±0.08 .000±0.02
ANGLE: ±1°	

绘图/DR	陈雄军
审核/CHECK	胡进
核准/APPRO	MR. feng
日期/DATE	2015-11-04

XYDZ® 东莞市祥运连接器有限公司
Dongguan XiangYun Connector s CO., Ltd

投影法
Projection

单位 Unit
MM

比例/Scale
1:1

大小/SIZE
A4

页码/SHEET
1/1

品名
(PART NAME)
ZH1.50mm SMT 90° Wafer

料号
(PART NO)
Connector Series

料号
(PART NO)
W1500SR-NP

修订版本	2015-11-04	陈雄军
变更图章格式内容	2013-12-27	陈雄军
新版本	2011-05-24	陈雄军
说明 DESCRIPTION	日期 DATE	承认 APPRO.
版本 REV.	1	

1	2	3	4	5	6	7	8	9	10
---	---	---	---	---	---	---	---	---	----

ROHS

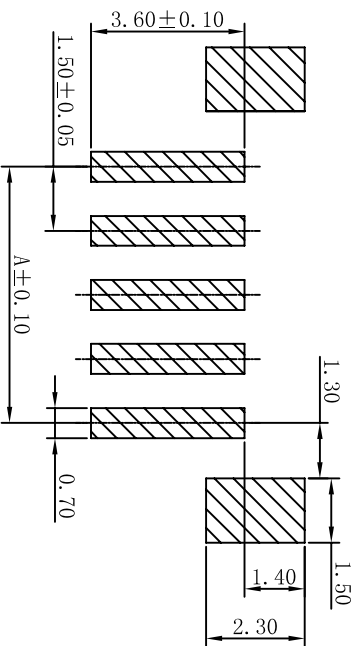
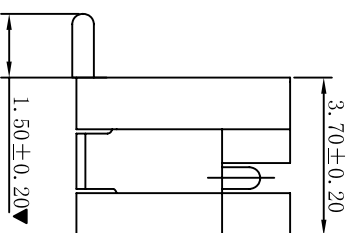
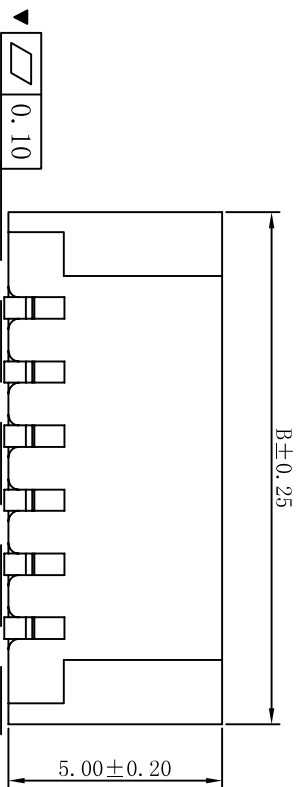
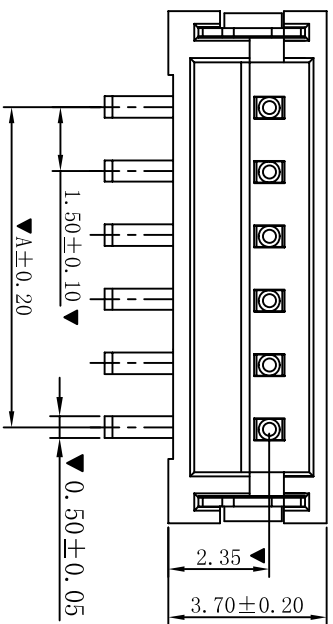

P.C.B LAYOUT

■ SPECIFICATIONS

- Voltage Rating: 50V AC, DC
- Current Rating: 1.0A, AC, DC
- Withstanding Voltage: 500V AC/minute
- Insulation Resistance: 100MΩ min
- Temperature range: -25°C~+85°C
- Contact resistance: 40mΩ max

■ WAFER

- Part No. : W1500SV-NP
- Poles : 02-15P
- Housing Material : Nylon 6T UL94V-0
- Pin Material : Brass /Tin-plated
- Solder Tab Material : Brass /Tin-plated
- The Dimension Marked “▼” Must Be Recorded

Contacts	Dimension (mm)	
	A	B
02	1.50	6.00
03	3.00	7.50
04	4.50	9.00
05	6.00	10.50
06	7.50	12.00
07	9.00	13.50
08	10.50	15.00
09	12.00	16.50
10	13.50	18.00
11	15.00	19.50
12	16.50	21.00
13	18.00	22.50
14	19.50	24.00
15	21.00	25.50

XYDZ® 东莞市祥运连接器有限公司
 Dongguan XiangYun Connector's CO., Ltd

一般公差 GENERAL TOLERANCE:	0±0.20 .0±0.13 .00±0.08 .000±0.02
绘图/DR	陈雄军
审核/CHECK	胡进
批准/APPRO	MR. feng
日期/DATE	2015-11-04

投影法 Projection	MM	品名 (PART NAME)	ZH1. 50mm SMT 180° Wafer
单位 Unit	1:1	料号 (PART NO)	W1500SV-NP
比例/Scale	A4		
大小/SIZE	1/1		
页码/SHEET	C		
版本/Rev			

修订版本	2015-11-04	陈雄军
变更图章格式内容	2013-12-27	陈雄军
新版本	2011-05-24	陈雄军
说明 DESCRIPTION	日期 DATE	承认 APPRO.
版次 REV.	1	